

Colour	Transparent	Material	PVC
Conduits Ø (mm)	16	Electrocod	210

DIMENSIONAL

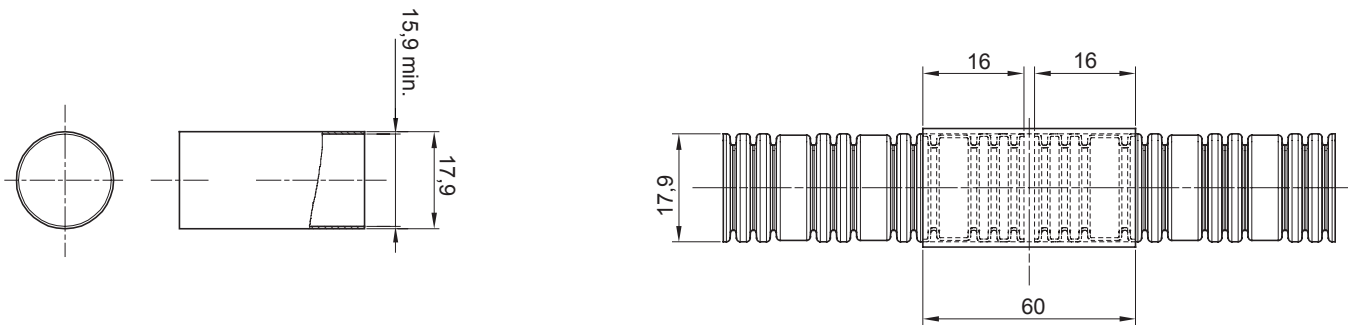

STANDARDS/APPROVALS

