

# ELIA PL M2 600 OP

Part number GWF1610MA840

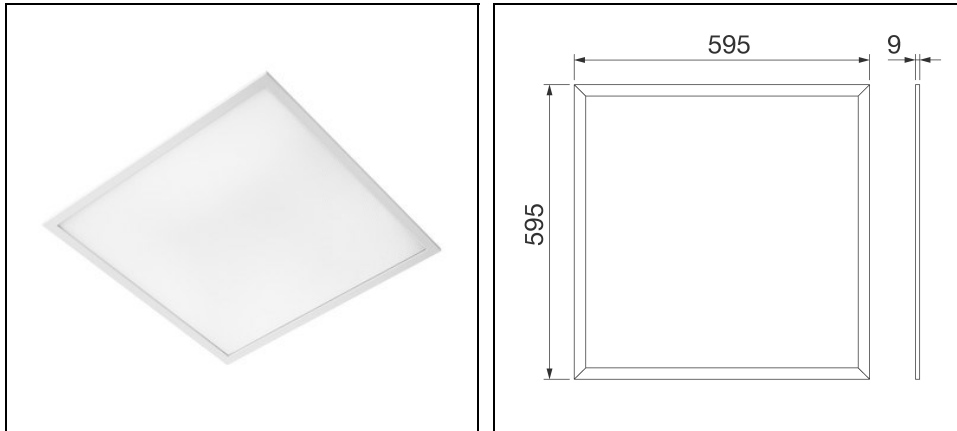

## Description

LED low bay for lighting offices

- Available in square or rectangular versions with a frame in white powder-coated die-cast aluminium and two types of PMMA shield, a high-efficiency micro-prism version with a UGR of less than 19 and an opal version with an UGR of 22
- The family of products is available with a colour temperature of 3,000K (warm white) or 4,000K (neutral white), a colour rendering index of more than 80 or more than 90 and a separate electronic power supply supplied as part of a kit, in On/Off or DALI versions
- ELIA PL is easy to install thanks to the reduced weight of the device and the connector for electrical wiring which enables connection to the remote power supply
- ELIA PL can be flush-mounted in false ceilings with standard panels, or alternatively, can be ceiling or suspension-mounted using the accessories provided separately
- External emergency kit with 3h autonomy available (to be ordered separately)
- The part numbers listed below with an MOQ require a minimum order quantity. Please consult our sales agents for information on availability, lead times, and volume requirements

To maintain the regular updating of our products, PERFORMANCE iN LIGHTING reserves the right to make changes without prior notice. For the most up to date information we always recommend you read the latest version published on the website [www.performanceinlighting.com](http://www.performanceinlighting.com). Delivered luminaire lumen outputs and power consumptions, including losses, are subject to a tolerance of +/- 7%, and unless otherwise stated the values apply to an ambient temperature of 25°C. Terms of warranty are available at <https://www.performanceinlighting.com/qr/company/led-warranty>

## Product data

ETIM Group:	EG000027	ETIM Class:	EC0028g2
-------------	----------	-------------	----------

## General information

Lampholder:	LED	Light source:	LED
Luminaire lumen output [lm]:	4300	Luminaire wattage [W]:	33 W
Luminous efficacy [lm/W]:	130	CRI:	80
Colour temperature [K]:	4000	Colour / Finishing:	WH-RAL9016 / White RAL9016
IP degree of protection:	IP20	IP above/below ceiling:	IP20/IP40
Impact resistance / impact energy:	IK03 0.35J xx1	Protection class:	II
Optic:	OPAL - Opal	Net weight [kg]:	2.79
Overall length [mm]:	595	Overall width [mm]:	595
Overall height [mm]:	9		

## Mechanical features

Housing material:	Aluminium	Diffuser material:	Plastic
Glow wire test [°C]:	650 °C		

## Electrical features

Voltage type:	AC	Input voltage [V AC]:	220/240
Input frequency [Hz]:	50/60		

## Installation

Application area:	Indoor lighting	Mounting type:	Ceiling recessed
Min. ambient temperature [°C]:	-20	Max. ambient temperature [°C]:	45

## Light features

MacAdam:	3	Lumen maintenance:	L80B50@50000h
Distribution of light emission:	Direct	UGR max.:	22.0

To maintain the regular updating of our products, PERFORMANCE iN LIGHTING reserves the right to make changes without prior notice. For the most up to date information we always recommend you read the latest version published on the website [www.performanceinlighting.com](http://www.performanceinlighting.com). Delivered luminaire lumen outputs and power consumptions, including losses, are subject to a tolerance of +/- 7%, and unless otherwise stated the values apply to an ambient temperature of 25°C. Terms of warranty are available at <https://www.performanceinlighting.com/qr/company/led-warranty>

## Photometric data

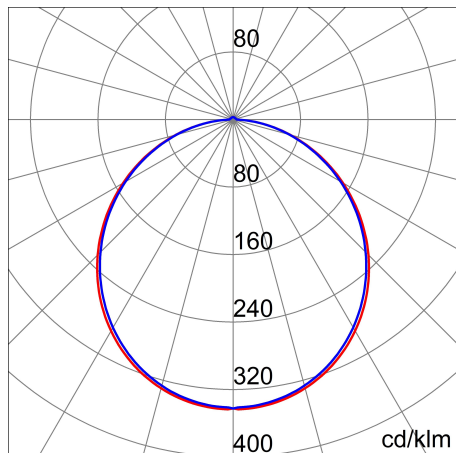

## Optional accessories

ELIA PL M2 600

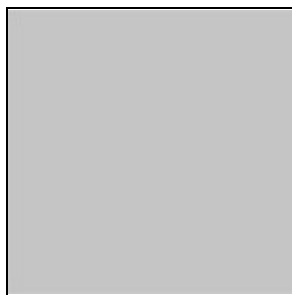

**GWF1921**  
Suspension kit with 4 cables

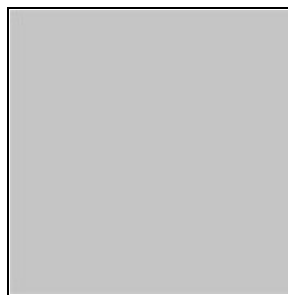

**GWF1923**  
Safety cable kit

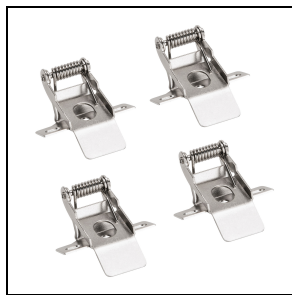

**GWF1922**  
Kit with 4 springs for flush-mounting

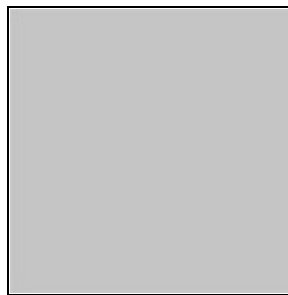

**GWF1911**  
Ceiling box kit 600x600 mm - white  
 WH-87 / White



**GWF1917**  
Assemblable ceiling box kit 600x600 mm - white  
 WH-87 / White

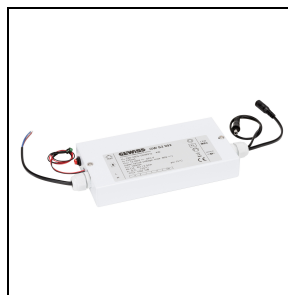

**GWS2992**  
Emergency kit 3h

To maintain the regular updating of our products, PERFORMANCE iN LIGHTING reserves the right to make changes without prior notice. For the most up to date information we always recommend you read the latest version published on the website [www.performanceinlighting.com](http://www.performanceinlighting.com). Delivered luminaire lumen outputs and power consumptions, including losses, are subject to a tolerance of +/- 7%, and unless otherwise stated the values apply to an ambient temperature of 25°C. Terms of warranty are available at <https://www.performanceinlighting.com/qr/company/led-warranty>