

Indoor | Pendants | Traceline Pendant Direct/Indirect

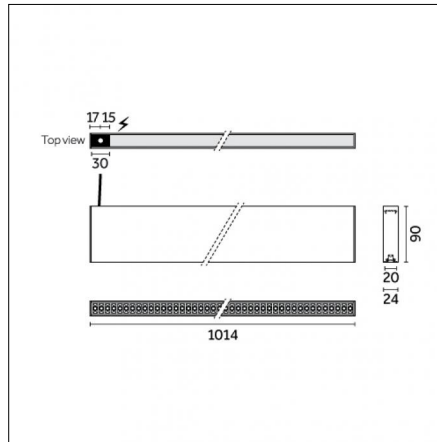
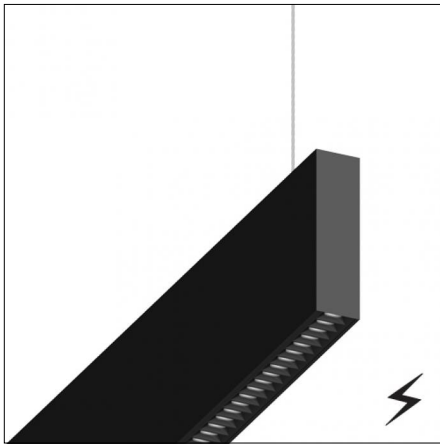

Very wide 40°

31

IP20



850°



5 YEAR



Code 0.S.FN85N.HN31

Light source features

Number of light sources direct light: 1

Source type: LED

Watt: 21W

Lm: 3360lm

Lm/W: 165lm/W

Kelvin/CRI: 4000K / >90

SDCM/L80 B10: < 3 / 50000

Number of light sources indirect light: 1

Source type: LED

Watt: 27W

Lm: 4100lm

Lm/W: 148lm/W

Kelvin/CRI: 4000K / >90

SDCM/L80 B10: < 3 / 50000

Electrical features

Driver included: YES

Driver type: On-Off 220/240 Vac 50/60 Hz

Total power consumption (LED + DRIVER): 56W

Isolation class: Class II

Optical features

Beam angle: 40°

Interchangeable optic (IOS): NO

UGR : < 16

Physical features

Material: Extruded aluminum

Diffusing screen: Dark Performance

Mounting: Suspension

Fixing: Ceiling

Finishing: Embossed matte black

Weight: 2.15Kg

Notes:

- Power module supplied with 3m power cable, suspension components to be ordered separately.

- End caps included.

1-10V products must be paired with active/source dimmer (dimmer must provide 1-10V signal and relevant current)

For customers and partners ordering from Germany Traceline System products are only offered and delivered under the product name Spoor.

Luminaire constructed in conformity with Directives 2014/35/EU (LV), 2014/30/EU (EMC), 2009/125/EC (Ecodesign) with Regulations (EC) No 245/2009, (EU) No 347/2010 and (EU) 2015/1428 (for luminaires with fluorescent and metal halide lamps only), 2009/125/EC (Ecodesign) with Regulations (EU) No 1194/2012 and 2015/1428 (for LED luminaires only), 2011/65/EU (RoHS 2) and 2012/19/EU (WEEE).

Reggiani Lighting Srl

Viale Monza, 16 20845 Sovico (MB) Italy
Tel. (+39) 039 2071.1 fax (+39) 039 2071 999

www.reggiani.net
contact@reggiani.net

Accessories

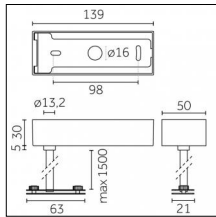

Code 0.26820.OP12 - Suspension set with 1,5m tige and long bracket (1x)

Type: Mounting
 Finishing: Embossed matte white
 Description: Ceiling surface base, aluminium box, 1,5m rod, long bracket (1x)

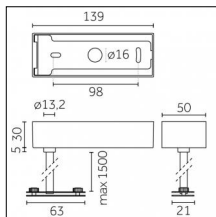

Code 0.26820.OP31 - Suspension set with 1,5m tige and long bracket (1x)

Type: Mounting
 Finishing: Embossed matte black
 Description: Ceiling surface base, aluminium box, 1,5m rod, long bracket (1x)

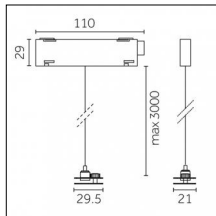

Code 0.26821.OP00 - Suspension set for 3-phase track - Short brackets (2x)

Type: Mounting
 Finishing: Without finish / Natural aluminium
 Description: Ghosttrack adapters (2x) for 3-phase track, 3000m cables, short brackets (2x)

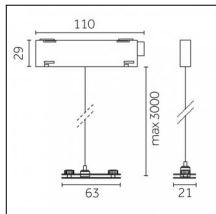

Code 0.26822.OP00 - Suspension set for 3-phase track - long bracket (1x)

Type: Mounting
 Finishing: Without finish / Natural aluminium
 Description: Ghosttrack adapter for 3-phase track, 3000m cable, long bracket (1x)

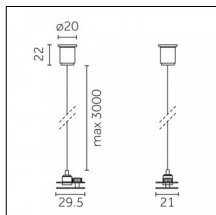

Code 0.26825.OP00 - Suspension set for 3000mm cable with short brackets (2x)

Type: Structural
 Finishing: Without finish / Natural aluminium
 Description: Short brackets (2x) with gripper Ø 1,5m, surface ceiling rose, 3000mm cable

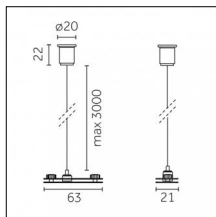
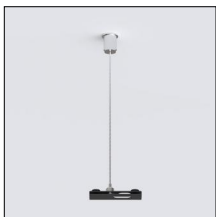

Code 0.26826.OP00 - Suspension set for 3000mm cable with long bracket (1x)

Type: Structural
 Finishing: Without finish / Natural aluminium
 Description: Long bracket with gripper Ø 1,5m, surface ceiling rose, 3000mm cable

Luminaire constructed in conformity with Directives 2014/35/EU (LV), 2014/30/EU (EMC), 2009/125/EC (Ecodesign) with Regulations (EC) No 245/2009, (EU) No 347/2010 and (EU) 2015/1428 (for luminaires with fluorescent and metal halide lamps only), 2009/125/EC (Ecodesign) with Regulations (EU) No 1194/2012 and 2015/1428 (for LED luminaires only), 2011/65/EU (RoHS 2) and 2012/19/EU (WEEE).

Accessories

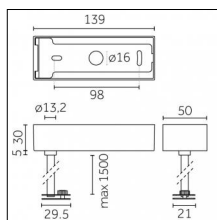

Code 0.26831.0P12 - Suspension set with 1,5m tige - short brackets (2x)

Type: Structural

Finishing: Embossed matte white

Description: Ceiling surface base, aluminium box, 1,5m rod, short brackets (2x)

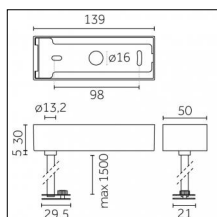

Code 0.26831.0P31 - Suspension set with 1,5m tige - short brackets (2x)

Type: Structural

Finishing: Embossed matte black

Description: Ceiling surface base, aluminium box, 1,5m rod, short brackets (2x)

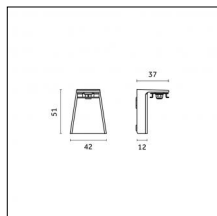

Code 0.26832.0P12 - Wall bracket

Type: Structural

Finishing: Embossed matte white

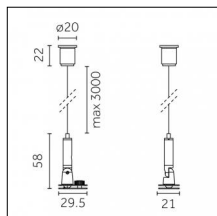

Code 0.26877.0P00 - Suspension accessory with stabilizer - short brackets (2x)

Type: Structural

Finishing: Without finish / Natural aluminium

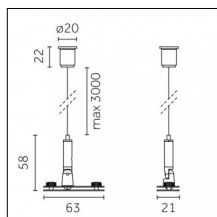
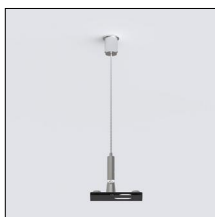

Code 0.26878.0P00 - Suspension accessory with stabilizer - long bracket

Type: Structural

Finishing: Without finish / Natural aluminium

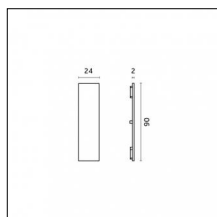
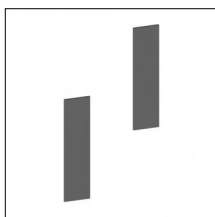

Code 0.26813.0001 - End caps (2x) Traceline Pendant Direct/Indirect

Type: Mounting

Finishing: *Chrome (On request)

Accessories

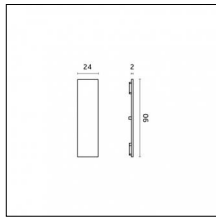
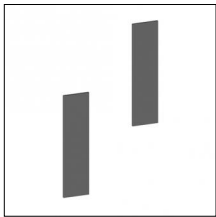

Code 0.26813.0012 - End caps (2x) Traceline Pendant Direct/Indirect

Type: Mounting
Finishing: Embossed matte white

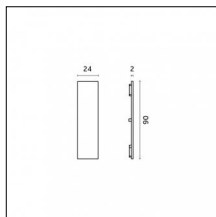
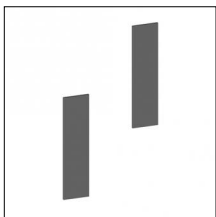

Code 0.26813.0031 - End caps (2x) Traceline Pendant Direct/Indirect

Type: Mounting
Finishing: Embossed matte black

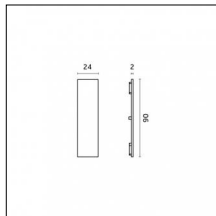
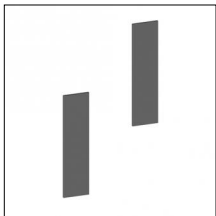

Code 0.26813.00B0 - End caps (2x) Traceline Pendant Direct/Indirect

Type: Mounting
Finishing: *Royal matte black (On request)

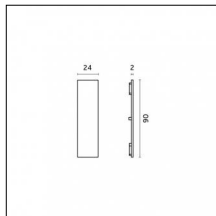
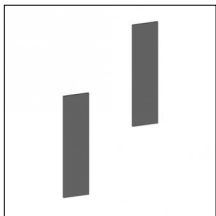

Code 0.26813.00C0 - End caps (2x) Traceline Pendant Direct/Indirect

Type: Mounting
Finishing: *Royal matte white (On request)

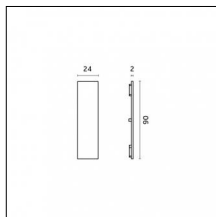
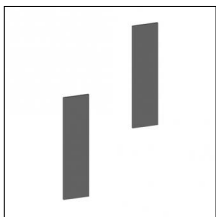

Code 0.26813.00D0 - End caps (2x) Traceline Pendant Direct/Indirect

Type: Mounting
Finishing: *Brushed brass (On request)

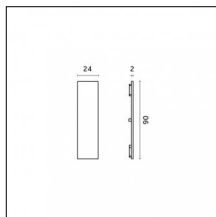
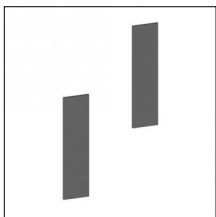

Code 0.26813.00E0 - End caps (2x) Traceline Pendant Direct/Indirect

Type: Mounting
Finishing: *Brushed gold (On request)

Accessories

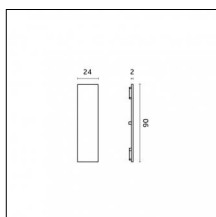
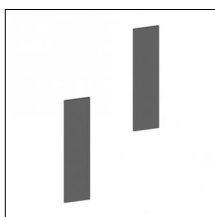

Code 0.26813.00L0 - End caps (2x) Traceline Pendant Direct/Indirect

Type: Mounting
Finishing: Antiqued brushed bronze (On request)

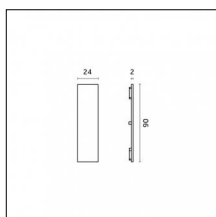
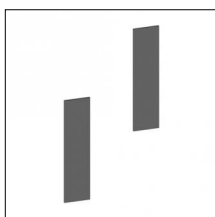

Code 0.26813.00M0 - End caps (2x) Traceline Pendant Direct/Indirect

Type: Mounting
Finishing: *Brushed aluminum (On request)

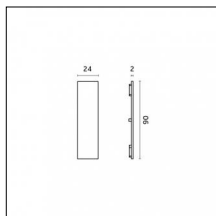
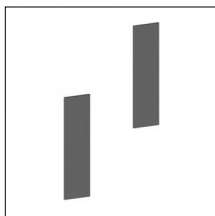

Code 0.26813.00N0 - End caps (2x) Traceline Pendant Direct/Indirect

Type: Mounting
Finishing: *Brushed copper (On request)

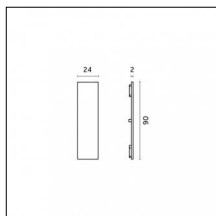
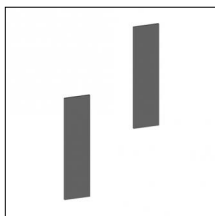

Code 0.26813.00T1 - End caps (2x) Traceline Pendant Direct/Indirect

Type: Mounting
Finishing: *Anodized Bronze (On request)

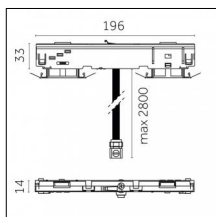

Code 0.26823.0000 - Power adapter ON-OFF/BLUETOOTH for 3-phase track suspension kit

Type: Mounting
Finishing: Without finish / Natural aluminium

Description: Traceline Pendant / Deep Pendant: the use of codes 0.26823 and 0.26824 requires the replacement of the cable supplied with the product with the one supplied with the accessory.

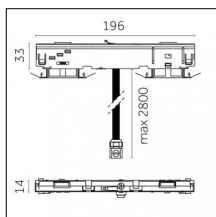

Code 0.26824.0000 - Power adapter DALI/dimm for 3-phase track suspension kit

Type: Mounting
Finishing: Without finish / Natural aluminium

Description: Traceline Pendant / Deep Pendant: the use of codes 0.26823 and 0.26824 requires the replacement of the cable supplied with the product with the one supplied with the accessory.

Accessories

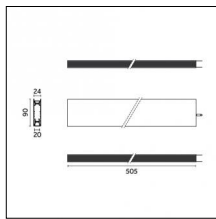
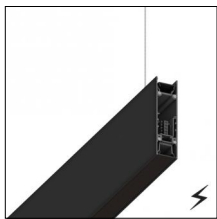

Code 0.26864.0012 - Electromechnical connection - Pendant- 500mm - Power

Type: Structural
Finishing: Embossed matte white

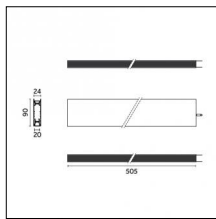
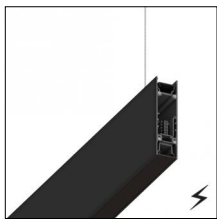

Code 0.26864.0031 - Electromechnical connection - Pendant- 500mm - Power

Type: Structural
Finishing: Embossed matte black

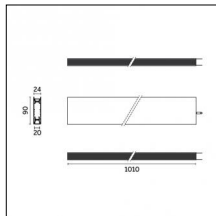
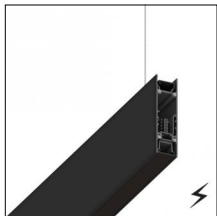

Code 0.26865.0012 - Electromechnical connection - Pendant- 1000mm - Power

Type: Structural
Finishing: Embossed matte white

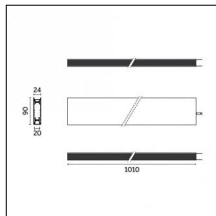
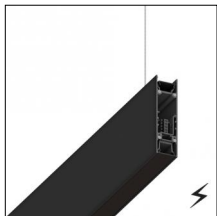

Code 0.26865.0031 - Electromechnical connection - Pendant- 1000mm - Power

Type: Structural
Finishing: Embossed matte black

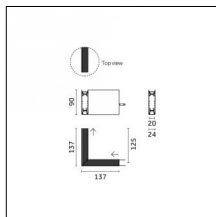
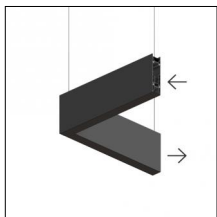

Code 0.26866.0012 - Electromechnical connection - Pendant- L - 125x125mm - Continuous

Type: Structural
Finishing: Embossed matte white

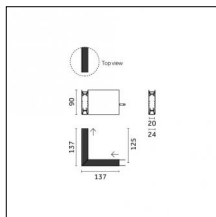
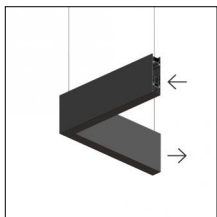

Code 0.26866.0031 - Electromechnical connection - Pendant- L - 125x125mm - Continuous

Type: Structural
Finishing: Embossed matte black

Luminaire constructed in conformity with Directives 2014/35/EU (LV), 2014/30/EU (EMC), 2009/125/EC (Ecodesign) with Regulations (EC) No 245/2009, (EU) No 347/2010 and (EU) 2015/1428 (for luminaires with fluorescent and metal halide lamps only), 2009/125/EC (Ecodesign) with Regulations (EU) No 1194/2012 and 2015/1428 (for LED luminaires only), 2011/65/EU (RoHS 2) and 2012/19/EU (WEEE).

Accessories

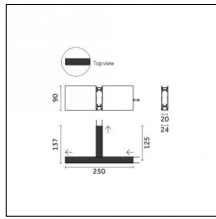
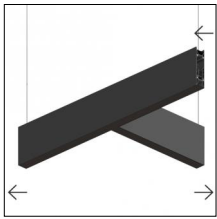

Code 0.26867.0012 - Electromechanical connection - Pendant-T - 250x125mm - Continuous

Type: Structural
Finishing: Embossed matte white

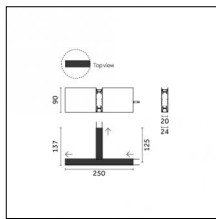
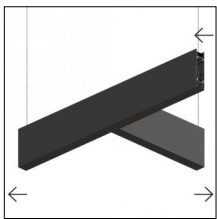

Code 0.26867.0031 - Electromechanical connection - Pendant-T - 250x125mm - Continuous

Type: Structural
Finishing: Embossed matte black

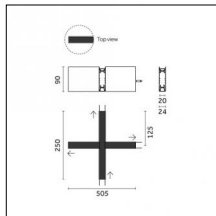
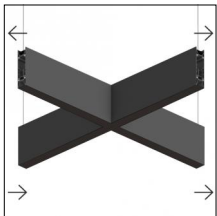

Code 0.26868.0012 - Electromechanical connection - Pendant-X - 250x250mm - Continuous

Type: Structural
Finishing: Embossed matte white

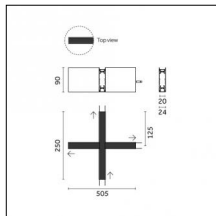
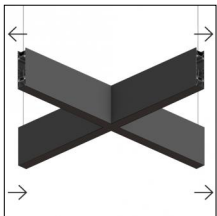

Code 0.26868.0031 - Electromechanical connection - Pendant-X - 250x250mm - Continuous

Type: Structural
Finishing: Embossed matte black

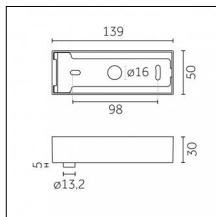

Code 0.26881.0012 - Surface trim base (without cable)

Finishing: Embossed matte white

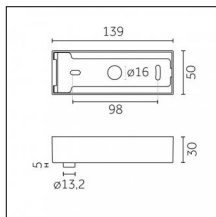

Code 0.26881.0031 - Surface trim base (without cable)

Finishing: Embossed matte black

Luminaire constructed in conformity with Directives 2014/35/EU (LV), 2014/30/EU (EMC), 2009/125/EC (Ecodesign) with Regulations (EC) No 245/2009, (EU) No 347/2010 and (EU) 2015/1428 (for luminaires with fluorescent and metal halide lamps only), 2009/125/EC (Ecodesign) with Regulations (EU) No 1194/2012 and 2015/1428 (for LED luminaires only), 2011/65/EU (RoHS 2) and 2012/19/EU (WEEE).

Accessories

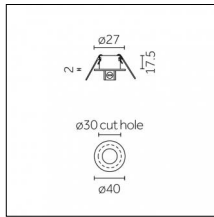

Code 0.26882.0012 - Recessed trimless base (without cable)

Finishing: Embossed matte white

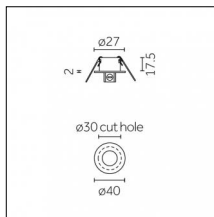

Code 0.26882.0031 - Recessed trimless base (without cable)

Finishing: Embossed matte black

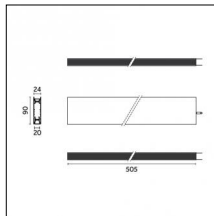
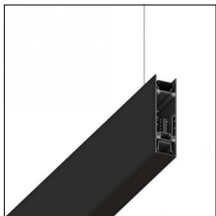

Code 0.26919.0012 - Electromechanical connection - Pendant- 500mm - Continuous

Type: Structural
Finishing: Embossed matte white

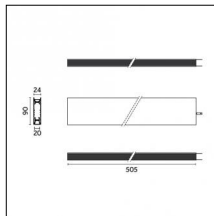
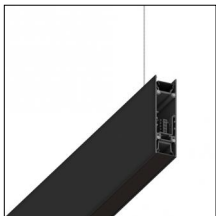

Code 0.26919.0031 - Electromechanical connection - Pendant- 500mm - Continuous

Type: Structural
Finishing: Embossed matte black

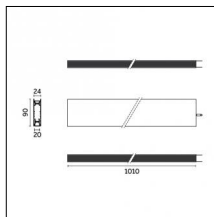
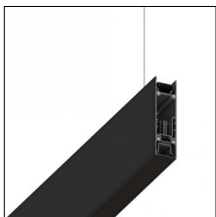

Code 0.26920.0012 - Electromechanical connection - Pendant- 1000mm - Continuous

Type: Structural
Finishing: Embossed matte white

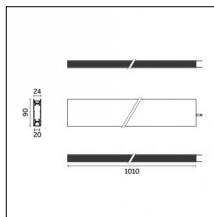
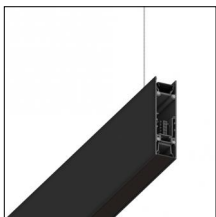

Code 0.26920.0031 - Electromechanical connection - Pendant- 1000mm - Continuous

Type: Structural
Finishing: Embossed matte black

Accessories

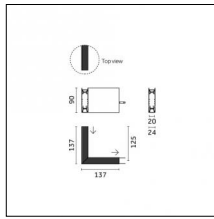
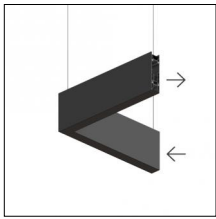

Code 0.26921.0012 - Electromechnical connection - Pendant - L - 125x125mm - Continuous

Type: Structural
Finishing: Embossed matte white

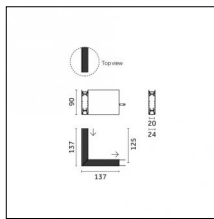
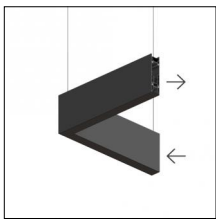

Code 0.26921.0031 - Electromechnical connection - Pendant - L - 125x125mm - Continuous

Type: Structural
Finishing: Embossed matte black

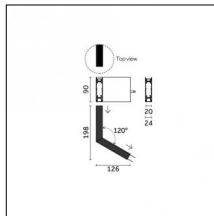
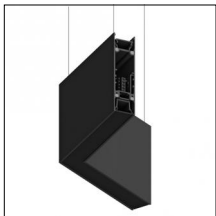

Code 0.26922.0012 - Electromechnical connection - Pendant - Continuous - 120°

Type: Structural
Finishing: Embossed matte white

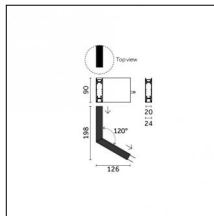
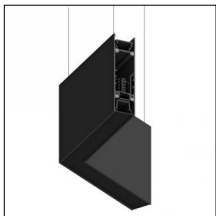

Code 0.26922.0031 - Electromechnical connection - Pendant - Continuous - 120°

Type: Structural
Finishing: Embossed matte black

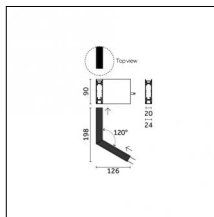
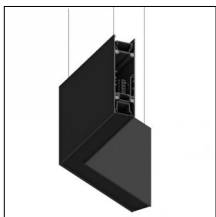

Code 0.26923.0012 - Electromechnical connection - Pendant - Continuous - 120°

Type: Structural
Finishing: Embossed matte white

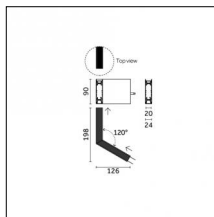
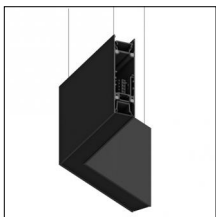

Code 0.26923.0031 - Electromechnical connection - Pendant - Continuous - 120°

Type: Structural
Finishing: Embossed matte black

Luminaire constructed in conformity with Directives 2014/35/EU (LV), 2014/30/EU (EMC), 2009/125/EC (Ecodesign) with Regulations (EC) No 245/2009, (EU) No 347/2010 and (EU) 2015/1428 (for luminaires with fluorescent and metal halide lamps only), 2009/125/EC (Ecodesign) with Regulations (EU) No 1194/2012 and 2015/1428 (for LED luminaires only), 2011/65/EU (RoHS 2) and 2012/19/EU (WEEE).

Accessories

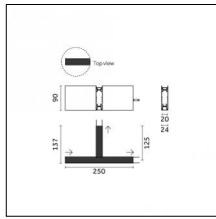
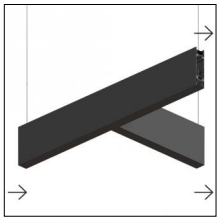

Code 0.26924.0012 - Electromechanical connection - Pendant- T - 250x125mm - Continuous

Type: Structural
Finishing: Embossed matte white

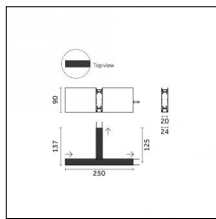
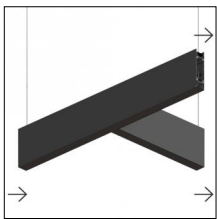

Code 0.26924.0031 - Electromechanical connection - Pendant- T - 250x125mm - Continuous

Type: Structural
Finishing: Embossed matte black

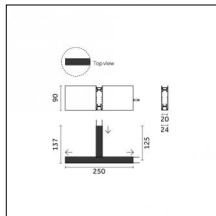
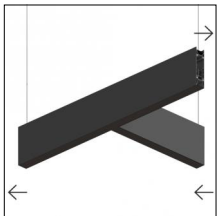

Code 0.26925.0012 - Electromechanical connection - Pendant- T - 250x125mm - Continuous

Type: Structural
Finishing: Embossed matte white

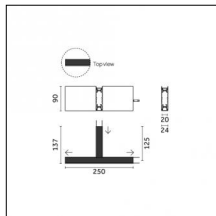
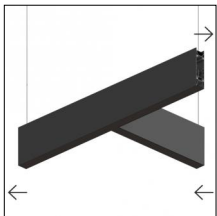

Code 0.26925.0031 - Electromechanical connection - Pendant- T - 250x125mm - Continuous

Type: Structural
Finishing: Embossed matte black

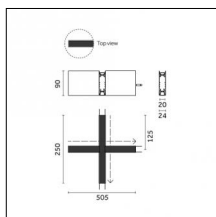
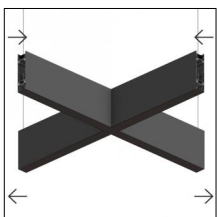

Code 0.26926.0012 - Electromechanical connection - Pendant- X - 250x250mm - Continuous

Type: Structural
Finishing: Embossed matte white

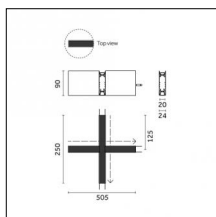
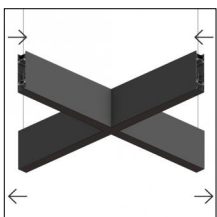

Code 0.26926.0031 - Electromechanical connection - Pendant- X - 250x250mm - Continuous

Type: Structural
Finishing: Embossed matte black

Luminaire constructed in conformity with Directives 2014/35/EU (LV), 2014/30/EU (EMC), 2009/125/EC (Ecodesign) with Regulations (EC) No 245/2009, (EU) No 347/2010 and (EU) 2015/1428 (for luminaires with fluorescent and metal halide lamps only), 2009/125/EC (Ecodesign) with Regulations (EU) No 1194/2012 and 2015/1428 (for LED luminaires only), 2011/65/EU (RoHS 2) and 2012/19/EU (WEEE).

Accessories

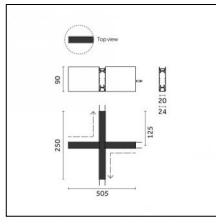
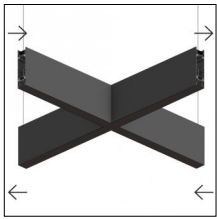

Code 0.26927.0012 - Electromechnical connection - Pendant- X - 250x250mm - Continuous

Type: Structural
Finishing: Embossed matte white

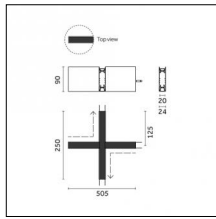
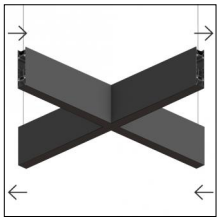

Code 0.26927.0031 - Electromechnical connection - Pendant- X - 250x250mm - Continuous

Type: Structural
Finishing: Embossed matte black

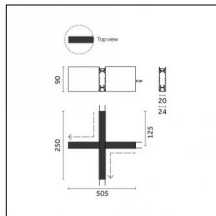
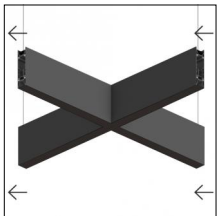

Code 0.26928.0012 - Electromechnical connection - Pendant- X - 250x250mm - Continuous

Type: Structural
Finishing: Embossed matte white

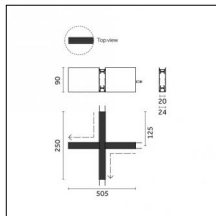
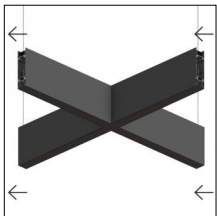

Code 0.26928.0031 - Electromechnical connection - Pendant- X - 250x250mm - Continuous

Type: Structural
Finishing: Embossed matte black

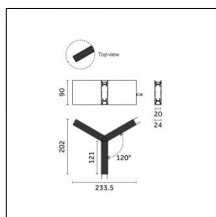
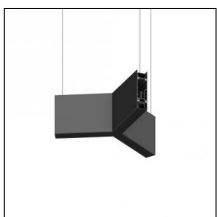

Code 0.26929.0012 - Electromechnical connection - Pendant- Y - Continuous

Type: Structural
Finishing: Embossed matte white

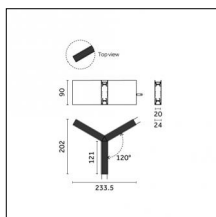
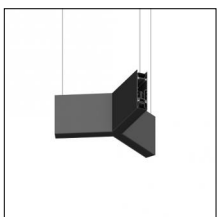

Code 0.26929.0031 - Electromechnical connection - Pendant- Y - Continuous

Type: Structural
Finishing: Embossed matte black

Luminaire constructed in conformity with Directives 2014/35/EU (LV), 2014/30/EU (EMC), 2009/125/EC (Ecodesign) with Regulations (EC) No 245/2009, (EU) No 347/2010 and (EU) 2015/1428 (for luminaires with fluorescent and metal halide lamps only), 2009/125/EC (Ecodesign) with Regulations (EU) No 1194/2012 and 2015/1428 (for LED luminaires only), 2011/65/EU (RoHS 2) and 2012/19/EU (WEEE).