



InfraRed Industrial Heat Incandescent

BR125 IR 250W E27 230-250V CL 1CT

The Philips infrared incandescent reflector lamps are designed to work in the toughest environment such as farm, bathroom or kitchen and their nearest surrounding. They have a reinforced construction thanks to hard glass use. Their compact form and universal cap base allow them to be used with any suitable equipment. A very good method of generating warmth is by using heat lamps. The Philips infrared lamps provide direct, draught-free warmth to the animals, people, but also food. These benefits have made farmers, consumers and cooks around the world choose Philips infrared lamps, because they are the sturdiest, most efficient lamps available for these applications.

Product data

• General Characteristics

Cap-Base	E27
Bulb	BR125
Bulb Material	Hard Glass
Bulb Finish	Clear
Operating Position	any [Any or Universal (U)]
Main Application	Infrared Industrial
Nominal Lifetime	5000 hr
Rated Lifetime (hours)	5000 hr

• Electrical Characteristics

Lamp Wattage	250 W
Voltage	230-250 V
Dimmable	Yes

• Luminaire Design Requirements

Pinch Temperature	275 (max) C
Bulb Temperature	500 (max) C

• Product Dimensions

Overall Length C	173 (max) mm
Diameter D	125 mm

• Product Data

Order code	923212143801
Full product code	923212143801
Full product name	BR125 IR 250W E27 230-250V CL 1CT
Order product name	BR125 IR 250W E27 230-250V CL 1CT/10
Pieces per pack	1
Packing configuration	10
Packs per outerbox	10
Bar code on pack - EAN1	8711500575234
Bar code on outerbox - EAN3	8727900209266
Logistic code(s) - 12NC	923212143801
Net weight per piece	104.000 gr

PHILIPS

Dimensional drawing

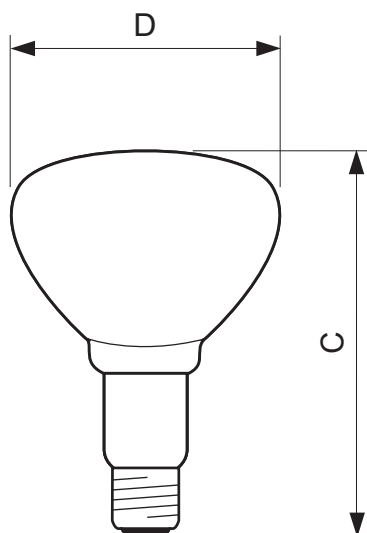

BR125 IR 250W E27 230-250V CL 1CT

Product	C (Min)	C (Norm)	C (Max)	D (Min)	D (Norm)	D (Max)
BR125 IR 250W E27 230-250V CL	-	-	173	-	125	-



E27



© 2015 Koninklijke Philips N.V. (Royal Philips)
All rights reserved.

Specifications are subject to change without notice. Trademarks are the property of Koninklijke Philips N.V. (Royal Philips) or their respective owners.

www.philips.com/lighting

2015, July 15
data subject to change