

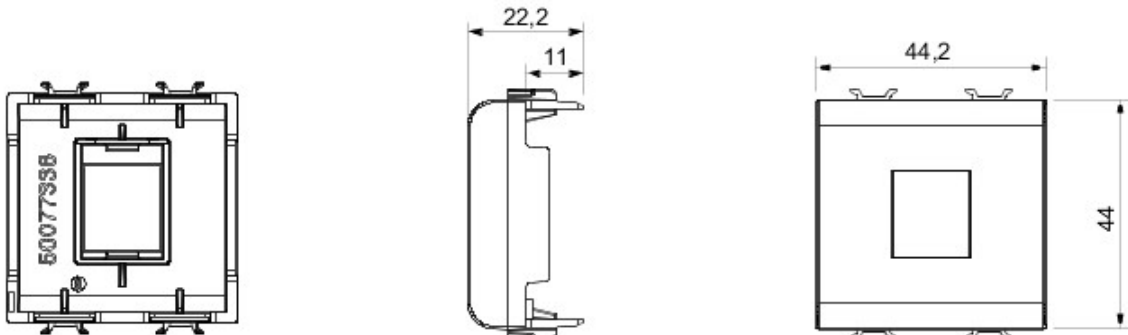

Wide range of switches, energy sockets (compliant with national and international standards), data sockets, devices for the management of climate control, comfort, technical alarms signalling, emergency lighting. The Chorus modular devices are available in five colors, glossy white, satin white, natural beige, satin black, painted titanium and in different modularities, 1/2, 1, 2 and 3 modules. Thanks to the frame supports for rectangular, square and round boxes, the devices allow you to create endless combinations with the range of Chorus plates.

Category	Adapter	Colour	Satin White
Compatibility	AMP / Keystone Jack	No. Chorus modules	2
Electrocod	0131		

DIMENSIONAL



STANDARDS/APPROVALS



GEWISS S.p.A. Via A. Volta, 1
24069 Cenate Sotto - Bergamo - Italy
tel. +39 035 94 61 11 fax +39 035 94 69 09

www.gewiss.com
sat@gewiss.com
Last update 03/06/2021

Data, measures, designs and pictures are shown only as informative purposes, and could be changed without previous notice