

LED highbay luminaire

LED highbay luminaire with single point suspension. Efficient LED lens technology offering a beam angle of 90° for homogeneous illumination. Luminaire input power: 140 W. Lifetime of 50.000h before luminous flux is reduced to 80 % of the initial value. Chromaticity tolerance (initial MacAdam): 5. Total luminous flux: 19000 lm@4000K, Luminaire efficacy: 136 lm/W. The housing is carefully designed to allow air flow cooling of the luminaire to prevent the components from overheating and ensures optimum performance in industrial environments. Surge protection up to 4kV. Pre-wired with mains cable (15 cm) including THORNeco Conny connector. Wide voltage driver 100-277V AC 50/60Hz. Body: die-cast aluminium, black (RAL 9017), Lens: PC Weight: 2.8 kg

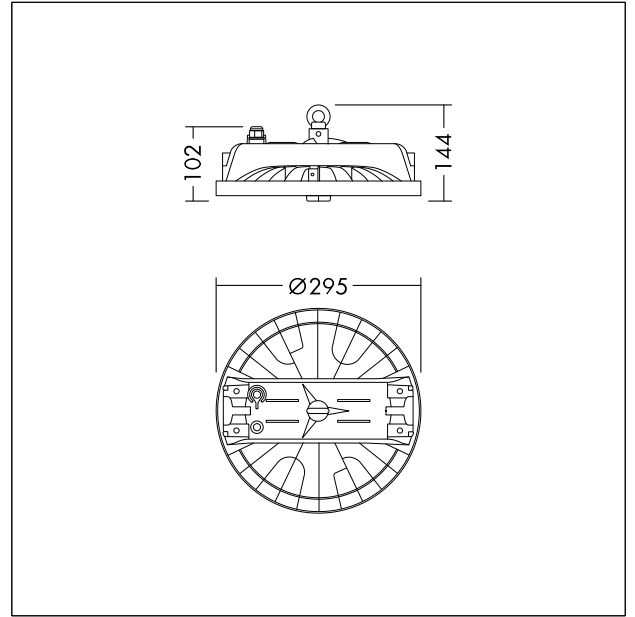

TE_BORIS_F_295_PERSP.jpg



TE_BORIS_M_300.wmf

Light Distribution

STD - standard

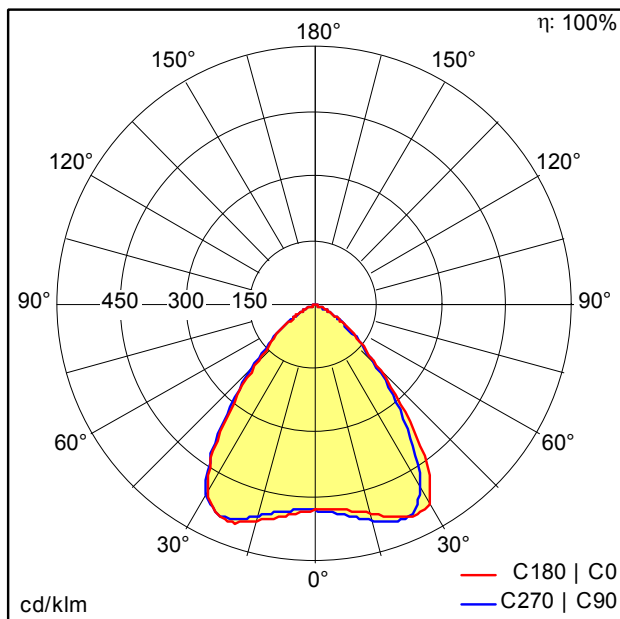

TE_BORIS_300_19000_840.idt

- Light Source: LED
- Luminaire luminous flux*: 19019 lm
- Luminaire efficacy*: 136 lm/W
- Colour Rendering Index min.: 80
- Correlated colour temperature: 4000 Kelvin
- Chromaticity tolerance (initial MacAdam): 5
- Rated median useful life*: L80 50000h at 25°C
- Ballast: 1x LED_Con
- Luminaire input power*: 140 W Power factor = 0.95
- Dimming: Fixed output

All values marked with an * are rated values. Luminous flux and connected electrical load are subject to an initial tolerance of +/- 10%. Unless stated otherwise, the values apply to an ambient temperature of 25°C.