

SLV GmbH

BETRIEBSANLEITUNG FÜR
DECKENEINBAULEUCHE

OPERATING MANUAL FOR
RECESSED CEILING LUMINAIRE

MODE D'EMPLOI POUR
ENCASTRÉ

INSTRUCCIONES DE SERVICIO PARA
LUMINARIA EMPOTRAR

ISTRUZIONI DI FUNZIONAMENTO PER
LAMPADA DA INCASSO

GEbruikshandleiding voor
PLAFONDINBOUWLAMP

INSTRUKTIONSVEJLEDNING FOR
INDBYGNINGSLAMPE

INSTRUKCJA OBSŁUGI DLA
LAMPY DO MONTAŻU W SUFICIE

РУКОВОДСТВО ПО ЭКСПЛУАТАЦИИ
СВЕТИЛЬНИК ДЛЯ МОНТАЖА В ПОТОЛКЕ

BRUKSANVISNING FÖR
TAKLAMPAN FÖR INFÄLLD MONTERING

TAVAN İÇİ LAMBA
İÇİN KULLANMA KILAVUZU

KEZELÉSI ÚTMUTATÓ
SÜLLYESZTETT MENNYEZETI LÁMPATEST

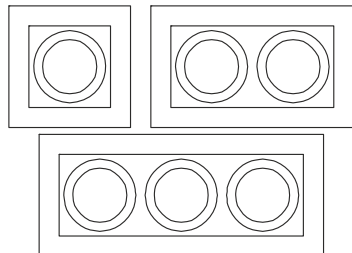

KADUX

230V~				115510/11/16	1x	QPAR51, GU10, 50W max.	9 x 9 x 13 cm	0,35 kg
				115520/21/26	2x		15 x 9 x 13 cm	0,55 kg
				115530/31/36	3x		21 x 9 x 13 cm	0,75 kg

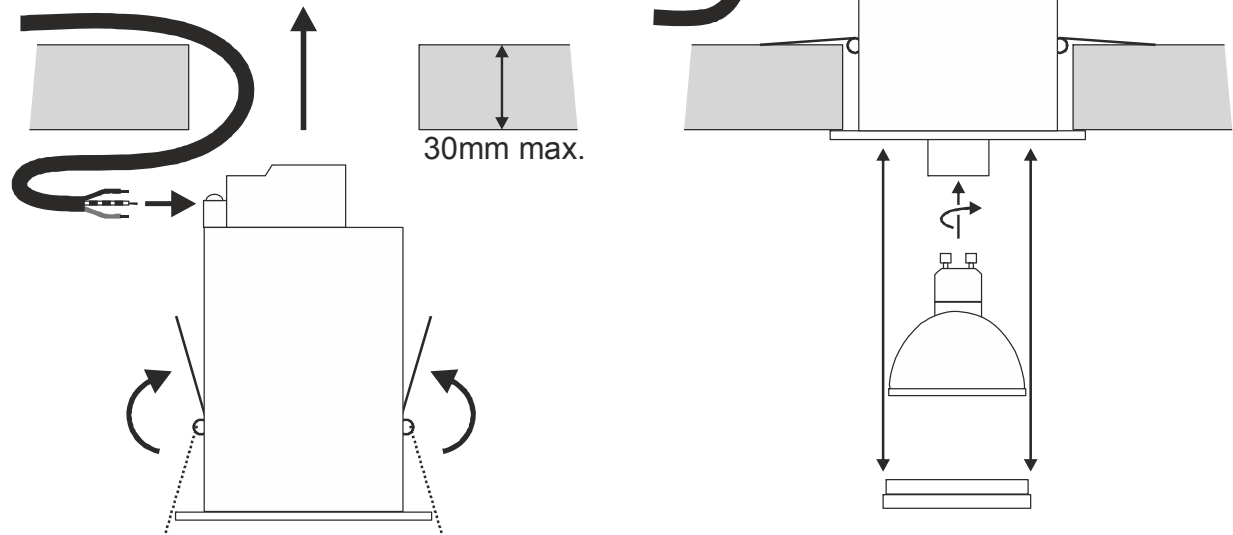
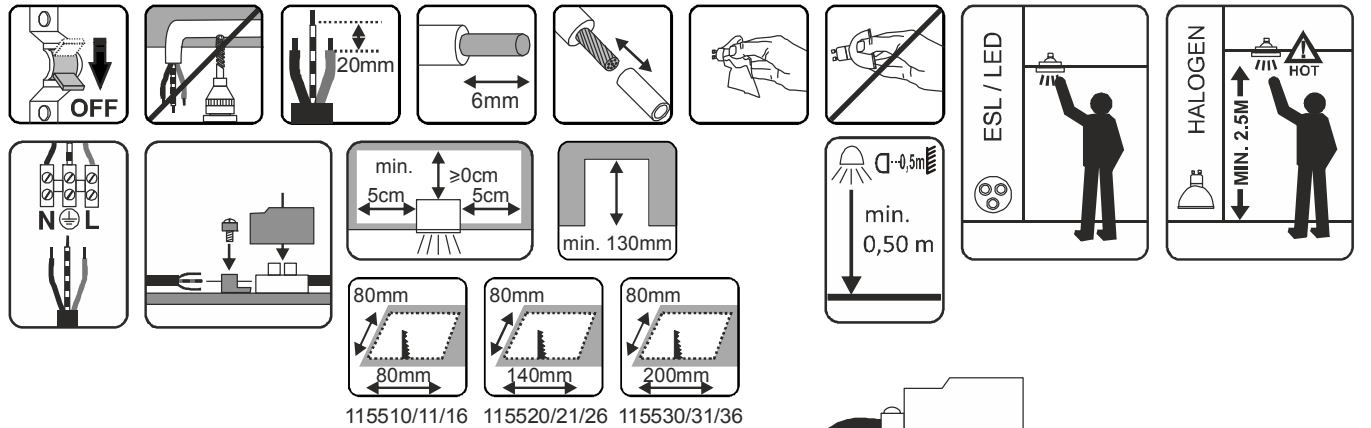

art.-no. 115510/11/16/20/21/26/30/31/36 07.05.2015 © SLV GmbH, Daimlerstr. 21-23, 52531 Übach-Palenberg, Germany, Tel. +49 (0)2451 4833-0 Technische Änderungen vorbehalten.
Technical Details are subject to change. Les détails techniques sont sujet à des changements. Nos reservamos el derecho a modificaciones técnicas. Modifiche tecniche riservate. Behoudens technische wijzigingen. Ret til tekniske ændringer forbeholdes. Zmiany techniczne zastrzeżone. Сохраняется право на внесение технических изменений. Tekniska ändringar kan förekomma. Teknik değışiklik yapma hakkı saklıdır. A technikai részletek termékenként változhatnak.

ENGLISH

OPERATING MANUAL FOR RECESSED CEILING LUMINAIRE 115516/26/36

Read this short manual carefully and keep it accessible for further reference!

SAFETY MESSAGES

Disregard of the safety messages may lead to danger of life, burning or fire!

- Installation, mounting or works on the electrical connection may only be carried out by an approved electrician.
- The product may not be modified or converted.
- Do not hang or fasten anything on the product, especially no decoration.
- Do not cover the product - provide free air circulation.
- In case of a malfunction you may NOT touch the product or operate it further. Disconnect the product from the power supply by an external switch or by the fuse.

A malfunction exists when:

- visible damages appear.
- the product does not work properly (e.g. flickering).
- smoke, steam or crackling sounds appear.
- smell of burning is recognisable.
- an overheating is recognisable (e.g. by discolouration of adjacent surfaces).

Operate the product only after maintenance and examination by an approved electrician!

- This product is not intended to be used by children. Ensure that children do not suffer any harm e.g. by burns from hot surfaces or by electrical shock.

Additional safety messages are indicated by this symbol: .

USE AS DIRECTED

This product serves exclusively lighting purposes and may:

- only be used with a voltage of 230V ~50Hz.
- only be installed according to safety class I (one).
- only be operated when firmly mounted on a stable, even and tilt-fixed surface.
- only be operated on normally or not flammable surfaces.
- only be used in dry condition,
 - not in damp or dirt-endangered rooms.
 - not in areas of high air humidity.
- not be exposed to strong mechanical loads or to strong contamination.

OPERATION

 The distance between the light source and the illuminated surface must be at least **0,5m**. Pay special caution to easily inflammable objects (e.g. curtains, fabrics, foliage, etc.).

MAINTANANCE AND CARE

Light source

 Exchange the light source always before it reaches its lifespan, to avoid personal injuries, or damages of the luminaire or other objects.

 Disconnect the product from the power supply, before you exchange the light source. Let the light source cool down before replacement.

 Use only light sources that are suitable for the product. Suitable light sources are indicated on the type label.

- Suitable light sources: QPAR51, GU10, 50W max.
- Replacing the light source
 - Remove the cover.
 - Remove the used light source.
 - Insert the new light source with a slight-turn to the right.
 - Attach the cover.

Care

 Disconnect the product from the power supply and let it cool down, before you clean the product.

- Clean the product on a regular basis using a slightly moistened, soft and fluff-free cloth. Please also note additional supplied notes on maintenance and care.

STORAGE AND DISPOSAL

Storage

- The product must be stored in a dry and clean environment. Do not strain the product mechanically during storage.

 After a damp or soiling storage the product may only be installed after checking its condition by an approved electrician.

Disposal (European Union)

- Do not dispose the product with the regular household waste! Products marked with this sign must be disposed according to the directive(WEEE, 2003/108) on electrical and electronic devices at local collection points for such devices!

INSTALLATION (only by an approved electrician)

 Switch off the mains or respectively the connection lead before doing any works!

 Use only parts, which are supplied with the product or are described as accessories!

 Inspect the product for loose parts inside the housing. When there are loose parts inside the housing and these are not explicitly described the product may not be installed or operated.

 Use the supplied fastening material only when it is suited for the installation background. If this is not the case use only fastening material suiting the installation background.

Unpacking

- Carefully take the product out of the packaging removing any transport safeguards.
- Before disposal of the packaging material make sure that all components of the product are removed.

Installation place

- The product is solely suited for recessed ceiling installation.
- Note the security advice on the distance to the illuminated surface in the chapter OPERATION.
- The surface of the luminaire may get very hot depending on the utilized

light source. This symbol, , indicates hot surfaces on a luminaire. When using halogen light sources the luminaire may only be installed and operated in a minimum height of 2,50m, outside of the arm's reach. Always use an existing handle when adjusting the direction of the luminaire.

- Note the minimum distances in the ceiling. Minimum distance to each side: 5 cm.

 Keep a sufficient distance to flammable surfaces. The indicated recess depth is the minimum depth. Depending on the installation situation the needed recess depth may be larger. This is especially the case, when there are flammable materials above the luminaire or to ensure the sufficient ventilation.

 Do not cover the product, especially not with insulating

materials: 

Installation steps (read completely before installation)

- Install the luminaire as shown in the figure.
- Mark and cut the opening. Do not damage the mains lead. The measurements for the openings are:
115510/11/16: L/W: 8/8 cm
115520/21/26: L/W: 14/8 cm
115530/31/36: L/W: 20/8 cm
- Remove the cover on top of the connection clamp.
- Loosen the strain relief. Direct the connection cord through the strain relief.
- Electrical Connection
 - The product must be able to be separated by an all pole separation from the current supply.
 - For electric connection attach the black or brown wire (live conductor) of the connection lead with the clamp L and the blue wire (neutral conductor) of the connection lead with the clamp N. The green-yellow wire (protective conductor) of the connection lead has to be tightly screwed into the earth clamp  of the product.
- Attach the cover back on the connection clamp.
- Secure the connection cord with the strain relief.
- Direct the luminaire into the opening, with the retaining springs pointing upwards.
- Inserting the light source
 - Remove the cover.
 - Insert the light source with a slight turn to the right.
 - Attach the cover.

 Check if the product functions properly and is securely fixed!

art.-no. 115510/11/16/20/21/26/30/31/36 © 07.05.2015 SLV GmbH,
Daimlerstr. 21-23, 52531 Übach-Palenberg, Germany,
Tel. +49 (0)2451 4833-0
Technical Details are subject to change.