

SLV GmbH

BETRIEBSANLEITUNG FÜR
WAND- UND DECKENLEUCHE

OPERATING MANUAL FOR
WALL- AND CEILING FITTING

MODE D'EMPLOI POUR
APPLIQUE / PLAFONNIER

INSTRUCCIONES DE SERVICIO PARA
LUMINARIA PARED / TECHO

ISTRUZIONI DI FUNZIONAMENTO PER
LAMPADA DA PARETE / SOFFITTO

GEbruIKSHANDLEIDING VOOR
WAND- EN PLAFONDLAMP

INSTRUKTIONSVEJLEDNING FOR
VÆGBELYSNING / LOFTBELYSNING

INSTRUKCJA OBSŁUGI DLA
LAMPY ŚCIENNA I SUFITOWA

РУКОВОДСТВО ПО ЭКСПЛУАТАЦИИ
НАСТЕННЫЙ И ПОТОЛОЧНЫЙ СВЕТИЛЬНИК

BRUKSANVISNING FÖR
VÄGG- OCH TAKLAMP

DUVAR VE TAVAN LAMBASI
IÇIN KULLANMA KILAVUZU

KEZELÉSI ÚTMUTATÓ
FALI- ÉS MENNYEZETI LÁMPATEST



TERANG 2

220V-240V
~50Hz



Power
11W



IP44

LED, 680 lm,
3000K, CRI>80

19,8 x 11,3 x 7,5 cm

0,42 kg

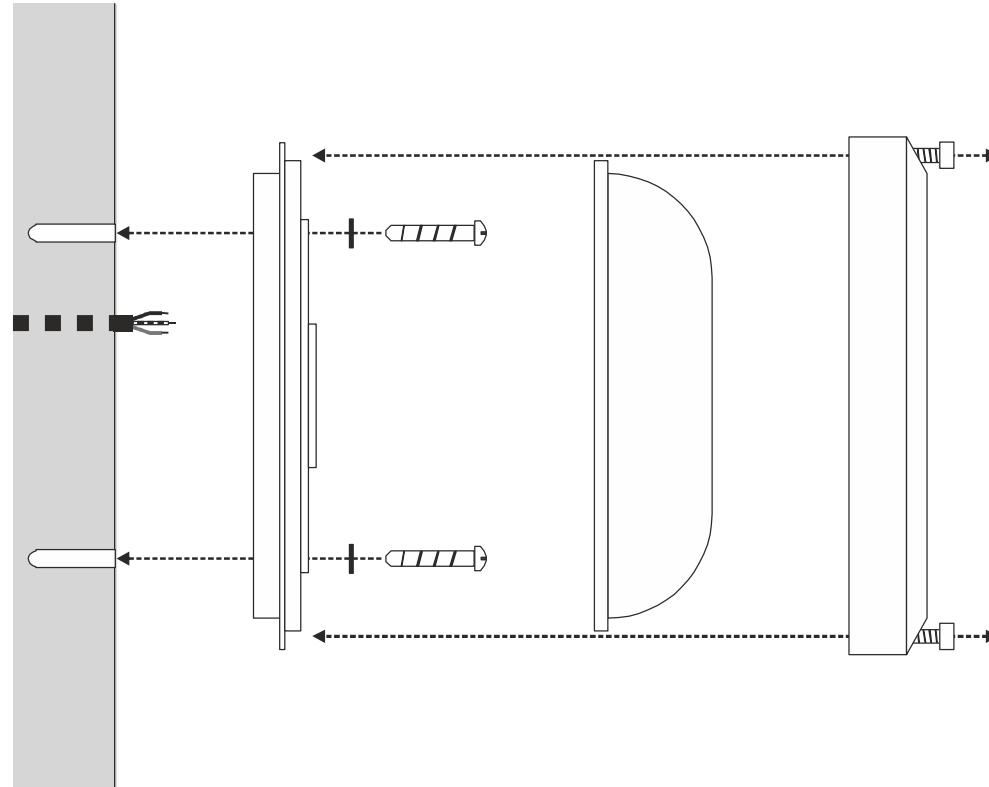
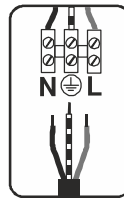
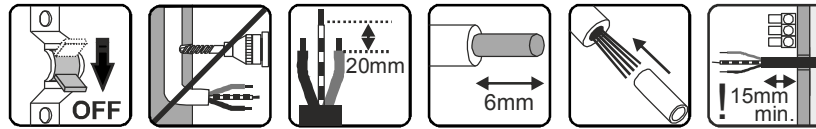

art.-no. 229931/34/35/37 14.12.2015 © SLV GmbH, Daimlerstr. 21-23, 52531 Übach-Palenberg, Germany, Tel. +49 (0)2451 4833-0 Technische Änderungen vorbehalten. Technical Details are subject to change. Les détails techniques sont sujet à des changements. Nos reservamos el derecho a modificaciones técnicas. Modifiche tecniche riservate. Behoudens technische wijzigingen. Ret til tekniske ændringer forbeholdes. Zmiany techniczne zastrzeżone. Сохраняется право на внесение технических изменений. Tekniska ändringar kan förekomma. Teknik değışiklik yapma hakkı saklıdır. A technikai részletek termékenként változhatnak.

ENGLISH

OPERATING MANUAL FOR WALL- AND CEILING FITTING TERANG 2

Read this short manual carefully and keep it accessible for further reference!

SAFETY MESSAGES

Disregard of the safety messages may lead to danger of life, burning or fire!

- Installation, mounting or works on the electrical connection may only be carried out by an approved electrician.
- Do not look directly into the light source.
- The product may not be modified or converted.
- Do not hang or fasten anything on the product, especially no decoration.
- Do not cover the product - provide free air circulation.
- The luminaire may only be operated with a complete and intact protection glass.
- In case of a malfunction you may NOT touch the product or operate it further. Disconnect the product from the power supply by an external switch or by the fuse.
A malfunction exists when:
 - visible damages appear.
 - the product does not work properly (e.g. flickering).
 - smoke, steam or crackling sounds appear.
 - smell of burning is recognisable.
 - an overheating is recognisable (e.g. by discolouration of adjacent surfaces).Operate the product only after maintenance and examination by an approved electrician!
- This product is not intended to be used by children. Ensure that children do not suffer any harm e.g. by burns from hot surfaces or by electrical shock.

Additional safety messages are indicated by this symbol: .

USE AS DIRECTED

This product serves exclusively lighting purposes and may:

- only be used with a voltage of 220-240V ~50Hz.
- only be installed according to safety class I (one).
- only be operated when firmly mounted on a stable, even and tilt-fixed surface.
- only be operated on normally or not flammable surfaces.
- not be exposed to strong mechanical loads or to strong contamination.

MAINTENANCE AND CARE

Light source

- The light source of this luminaire may only be replaced by the manufacturer, an authorized service technician or a comparable qualified person.

Care

- The following environmental influences may have unwanted effects on the surface of the product:
 - acid rain and sour soil, high salt content in the air
 - cleaning agents, fertilizer especially in flowerbeds
 - thawing salt, other chemical substances (e.g. herbicides)Protect the product by adequate means to avoid unwanted changes of the surface.

-  Disconnect the product from the power supply and let it cool down, before you clean the product.
- Clean the product on a regular basis using a slightly moistened, soft and fluff-free cloth. Please also note additional supplied notes on maintenance and care.

STORAGE AND DISPOSAL

Storage

- The product must be stored in a dry and clean environment. Do not strain the product mechanically during storage.
 After a damp or soiling storage the product may only be installed after checking its condition by an approved electrician.

Disposal (European Union)

- Do not dispose the product with the regular household waste! Products marked with this sign must be disposed according to the directive (WEEE, 2012/19) on electrical and electronic devices at local collection points for such devices!

INSTALLATION (only by an approved electrician)

 Switch off the mains or respectively the connection lead before doing any works!

 Use only parts, which are supplied with the product or are described as accessories!

 Inspect the product for loose parts inside the housing. When there are loose parts inside the housing and these are not explicitly described the product may not be installed or operated.

 Use the supplied fastening material only when it is suited for the installation background. If this is not the case use only fastening material suiting the installation background.

Unpacking

- Carefully take the product out of the packaging removing any transport safeguards.
- Before disposal of the packaging material make sure that all components of the product are removed.

Installation place

- The product is solely suited for installation on the wall and ceiling.
- The luminaire must be positioned in a way that a prolonged looking into the luminaire at a distance smaller than 0,3 m is not to be expected.
- LED react sensitive on high temperatures! Before installation pay attention to the expected temperature at the place of operation.

 The product may only be utilized according to IP44.
IP44: Protection against foreign objects > Ø 1,0mm - Protection against splashing water from all directions.

 Prepare the power supply lead according to valid rules for outdoor installations.

 Do not seal the product yourself, using additional silicon or another sealant.

Installation steps (read completely before installation)

- Install the luminaire as shown in the figure.
- Electrical Connection
 - The product must be able to be separated by an all pole separation from the current supply.
 - Direct the connection lead with its complete insulation through the cable entry into the housing.
 - For electric connection attach the black or brown wire (live conductor) of the connection lead with the clamp L and the blue wire (neutral conductor) of the connection lead with the clamp N. The green-yellow wire (protective conductor) of the connection lead has to be tightly screwed into the earth clamp  of the product.

 Check if the product functions properly and is securely fixed!

art.-no. 229931/34/35/37 © 14.12.2015 SLV GmbH,
Daimlerstr. 21-23, 52531 Übach-Palenberg, Germany,
Tel. +49 (0)2451 4833-0
Technical Details are subject to change.